

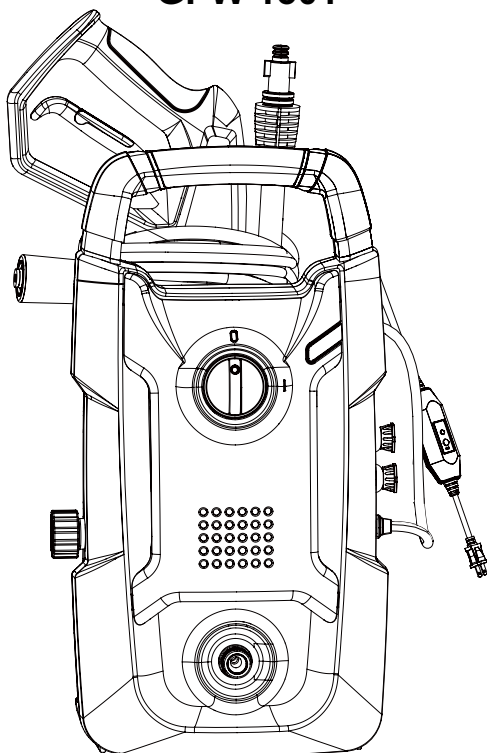

**1500 PSI / 1.2 GPM
ELECTRIC PRESSURE WASHER
GPW 1501**



OPERATOR'S MANUAL

TOLL-FREE HELPLINE: 1-888-90WORKS (888.909.6757)



Read all safety rules and instructions carefully before operating this tool.

www.greenworkstools.com

INSTRUCTION

| | |
|-------------------------------------|-------|
| Imporatant Safety Instructions..... | 3 |
| Specific Safety Rules..... | 4-5 |
| Symbols..... | 6-7 |
| Electrical..... | 8 |
| Know Your Pressure Washer..... | 9 |
| Packing List..... | 10 |
| Assembly..... | 11-14 |
| Operation..... | 15-19 |
| Maintenance..... | 20-22 |
| Troubleshooting..... | 23-25 |
| Warranty..... | 26 |
| Exploded View..... | 27 |
| Parts List..... | 28-29 |

PRODUCT SPECIFICATION

| | |
|---|-------------------|
| Universal Motor..... | 120V,60Hz, 13Amps |
| Power Cord with In-Line GFCI..... | 35ft |
| Max. Pounds Per Square Inch Pressure..... | 1500psi |
| Rated Gallons Per Minute..... | 1.2gpm |
| Maximum Inlet Water Temperature..... | 104°F (40 C) |
| Cleaning Units..... | 1800 C.U |
| Unit Weight..... | 19.07lbs(8.64kg) |



IMPORTANT SAFETY INTRODUCTIONS

WARNING

Read and understand all instructions. Failure to follow all instructions listed below may result in electric shock, fire, and /or serious personal injury.

WARNING

When using this product, basic precaution should always be followed, including the following.

READ ALL INSTRUCTIONS BEFORE USING THIS PRODUCT

- To reduce the risk of injury, close supervision is necessary when a product is used near children.
 - Be thoroughly familiar with controls. Know how to stop the product and release pressure quickly.
 - Stay alert and exercise control. Watch what you are doing and use common sense. Do not operate the product when you are tired. Do not rush.
 - Do not operate the product while under the influence of drugs, alcohol, or any medication.
 - Keep the area of operation clear of all people, particularly small children, and pets.
 - Don't overreach or stand on unstable support. Keep proper footing and balance at all times.
 - Follow the maintenance instructions specified in this manual.
-

WARNING

Risk of injection or injury – Do not direct discharge stream at people or animals.

GROUND FAULT CIRCUIT INTERRUPTER PROTECTION

This pressure washer is provided with a ground fault circuit interrupter (GFCI) built into the plug of the power supply cord. This device provides additional protection from the risk of electric shock. Should replacement of the plug or cord become necessary, use only identical replacement parts that include GFCI protection.

SERVICING OF A DOUBLE-INSULATED APPLIANCE

In a double-insulated product, two systems of insulation are provided instead of grounding. No grounding means is provided on a double-insulated product, nor should a means for grounding be added to the product. Servicing a double insulated product requires extreme care and knowledge of the system, and should be done only by qualified service personnel. Replacement parts for a double insulated product must be identical to the parts they replace. A double insulated product is marked with the words "DOUBLE INSULATION" or "DOUBLE INSULATED." The symbol  may also be marked on the product.

EXTENSION CORDS

- Do not use with extension cord. Plug directly into receptacle.
-

WARNING

To reduce the risk of electrocution, keep all connections dry and off the ground. Do not touch plug with wet hands.

SPECIFIC SAFETY RULES

- **Know your product. Read the operator's manual carefully.** Learn the machine's applications and limitations as well as the specific potential hazards related to this product.
- **To reduce the risk of injury, keep children and visitors away.** All visitors should wear safety glasses and be kept a safe distance from the work area.
- **Use the right product for the job.** Don't force the product or the attachments to do a job it was not designed for. Don't use it for a purpose not intended.
- **Dress properly.** Do not wear loose clothing, gloves, neckties, or jewellery. They can get caught and draw you into moving parts. Rubber gloves and nonskid footwear are recommended when working outdoors. Also wear protective hair covering to contain long hair.
- **Do not operate the equipment while barefoot or when wearing sandals or similar lightweight footwear.** Wear protective footwear that will protect your feet and improve your footing on slippery surfaces.
- **Exercise caution to avoid slipping or falling.**
- **Always wear eye protection with side shields marked to comply with ANSI Z87.1.** Following this rule will reduce the risk of serious personal injury.
- **Use only recommended accessories.** The use of improper accessories may cause risk of injury.
- **Check damaged parts.** Before further use of the product, all parts should be carefully checked to determine that they will operate properly and perform their intended function. Check for alignment of moving parts, binding of moving parts, breakage of parts, mounting, and any other conditions that may affect its operation. A guard or other part that is damaged must be properly repaired or replaced by an authorized service center to avoid risk of personal injury.
- **Never leave product running unattended.** Turn power off. Do not leave the product until it comes to a complete stop.
- **Keep the motor free of grass, leaves, or grease to reduce the chance of a fire hazard.**
- **Follow manufacturer's recommendations for safe loading, unloading, transport, and storage of machine.**
- **Keep product dry, clean, and free from oil and grease.** Always use a clean cloth when cleaning. Never use brake fluids, gasoline, petroleum-based products, or any solvents to clean product.
- **Check the work area before each use.** Remove all objects such as rocks, broken glass, nails, wire, or string which can be thrown by the machine.
- **Do not use product if switch does not turn it off.** Have defective switches replaced by an authorized service center.
- **Avoid dangerous environment.** Don't expose to rain. Keep work area well lit.
- **Do not abuse the cord.** Never use the cord to carry the product or to disconnect the plug from an outlet. Keep cord away from heat, oil, sharp edges, or moving parts. Replace damaged cords immediately. Damaged cords increase the risk of electric shock.
- **Ground Fault Circuit Interrupter (GFCI) protection should be provided on the circuit(s) or outlet(s) to be used for the product** Receptacles are available having built-in GFCI protection and may be used for this measure of safety.
- **To reduce the risk of electric shock, this product has a polarized plug (one blade is wider than the other) and will require the use of a polarized extension cord.** The plug will fit into a polarized extension cord only one way. If the plug does not fit fully into the extension cord, reverse the plug. If the plug still does not fit, obtain a correct polarized extension cord. A polarized extension cord will require the use of a polarized wall outlet. This plug will fit into the polarized wall outlet only one way. If the plug does not fit fully into the wall outlet, reverse the plug. If the plug still does not fit, contact a qualified electrician to install the proper wall outlet. Do not change the equipment plug, extension cord receptacle, or extension cord plug in any way.

SPECIFIC SAFETY RULES

- **Make sure your extension cord is in good condition.** When using an extension cord, be sure to use one heavy enough to carry the current your product will draw. A wire gauge size (A.W.G.) of at least 14 is recommended for an extension cord 25 feet or less in length. If in doubt, use the next heavier gauge. The smaller the gauge number, the heavier the cord. An undersized cord will cause a drop in line voltage resulting in loss of power and overheating.
- **Inspect extension cords periodically and replace if damaged.** Keep handles dry, clean, and free from oil or grease.
- **Never direct a water stream toward people or pets, or any electrical device.**
- **Before starting any cleaning operation, close doors and windows.** Clear the area to be cleaned of debris, toys, outdoor furniture, or other objects that could create a hazard.
- **Do not use acids, alkalines, solvents, flammable material, bleaches, or industrial grade solutions in this product.** These products can cause physical injuries to the operator and irreversible damage to the machine.

WARNING

High pressure jets can be dangerous if subject to misuse. The jet must not be directed at people, animals, electrical devices, or the machine itself.

- **Keep the motor away from flammables and other hazardous materials.**
- **Check bolts and nuts fixing the pressure washer shell for looseness before each use.** A loose bolt or nut may cause serious motor problems.
- **Before storing, allow the motor to cool.**
- **When servicing use only identical replacement parts.** Use of any other parts may create a hazard or cause product damage.
- **ONLY use cold water.**
- **Make sure minimum clearance of 3 feet is maintained from combustible materials.**
- **Connect pressure washer only to an individual branch circuit.**
- **Hold the handle and wand securely with both hands.** Expect the trigger handle to move when the trigger is pulled due to reaction forces. Failure to do so could cause loss of control and injury to yourself and others.
- **Save these instructions.** Refer to them frequently and use them to instruct other users. If you loan someone this product, loan them these instructions also.

WARNING

Some dust created by power sanding, sawing, grinding, drilling, and other construction activities contains chemicals known to cause cancer, birth defects or other reproductive harm. Some examples of these chemicals are:

- Lead from lead-based paints
- Crystalline silica from bricks and cement and other masonry products
- Arsenic and chromium from chemically-treated lumber









Your risk from these exposures varies, depending on how often you do this type of work. To reduce your exposure to these chemicals: work in a well ventilated area, and work with approved safety equipment, such as those dust masks that are specially designed to filter out microscopic particles.

WARNING

This product contains chemical(s) including lead, known to the State of California to cause cancer, birth defects, and other reproductive harm. Do not drink water from this hose. Wash hands after use.

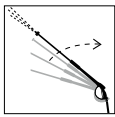

SYMBOLS

Some of the following symbols may be used on this product. Please study them and learn their meaning. Proper interpretation of these symbols will allow you to operate the product better and safer.

| SYMBOL | NAME | DESIGNATION/EXPLANATION |
|---|------------------------|---|
| V | Volts | Voltage |
| A | Amperes | Current |
| Hz | Hertz | Frequency (cycles per second) |
| W | Watt | Power |
| no | No Load Speed | Rotational speed, at no load |
|  | Alternating Current | Type of current |
| .../min | Per Minute | Revolutions, strokes, surface speed, orbits etc., per minute |
|  | Class II Construction | Double-insulated construction |
|  | Safety Alert | Indicates a potential personal injury hazard. |
|  | Read Operator's Manual | To reduce the risk of injury, user must read and understand operator's manual before using this product. |
|  | Eye Protection | Always wear eye protection with side shields marked to comply with ANSI Z87.1. |
|  | Wet Conditions Alert | Do not expose to rain or use in damp locations. |
|  | Risk of Injection | To reduce the risk of injection or injury, never direct a water system towards people or pets or place any body part in the stream. Leaking hoses and fittings are also capable of causing injection injury. Do not hold hoses or fittings. |
|  | Kickback | To reduce the risk of injury from kickback, hold the spray wand securely with both hands when the machine is on. |
|  | Electric Shock | Failure to use in dry conditions and to observe safe practices can result in electric shock. |
|  | Chemical Burns | To reduce the risk of injury or damage, DO NOT USE ACIDS, ALKALINES, BLEACHES, SOLVENTS, FLAMMABLE MATERIAL, OR INDUSTRIAL GRADE SOLUTIONS in this product. |

SYMBOLS

The following signal words and meanings are intended to explain the levels of risk associated with this product.

| SYMBOL | SIGNAL | MEANING |
|--|---------|--|
|  | DANGER | Indicates an imminently hazardous situation, which, if not avoided, will result in death or serious injury. |
|  | WARNING | Indicates a potentially hazardous situation, which, if not avoided, could result in death or serious injury. |
|  | CAUTION | Indicates a potentially hazardous situation, which, if not avoided, may result in minor or moderate injury. |
| | CAUTION | (Without Safety Alert Symbol) Indicates a situation that may result in property damage. |

SERVICE

Servicing requires extreme care and knowledge and should be performed only by a qualified service technician. For service, return the product to your nearest **AUTHORIZED SERVICE CENTER** for repair. When servicing, use only identical replacement parts.

WARNING

To avoid serious personal injury, do not attempt to use this product until you read thoroughly and understand completely the operator's manual. If you do not understand the warnings and instructions in the operator's manual, do not use this product. Call GREENWORKS customer service for assistance.



The operation of any power tool can result in foreign objects being thrown into your eyes, which can result in severe eye damage. Before beginning power tool operation, always wear safety goggles or safety glasses with side shields and, when needed, a full face shield. We recommend Wide Vision Safety Mask for use over eyeglasses or standard safety glasses with side shields. Always use eye protection which is marked to comply with ANSI Z87.1.

ELECTRICAL

⚠ WARNING

The double insulated system is intended to protect the user from shock resulting from a break in the product's internal insulation. Observe all normal safety precautions to avoid electrical shock.

DOUBLE INSULATED

Double insulation is a concept in safety in electric power tools, which eliminates the need for the usual three-wire grounded power cord. All exposed metal parts are isolated from the internal metal motor components with protecting insulation. Double insulated products do not need to be grounded.

NOTE: Servicing of a product with double insulation requires extreme care and knowledge of the system and should be performed only by a qualified service technician. For service, we suggest you return the product to your nearest authorized service center for repair. Always use identical replacement parts when servicing.

ELECTRICAL CONNECTION

This product has a precision-built electric motor. It should be connected to a power supply that is 120 volts, 60 Hz, AC only (normal household current). Do not operate this product on direct current (DC). A substantial voltage drop will cause a loss of power and the motor will overheat. If the product does not operate when plugged into an outlet, double check the power supply.

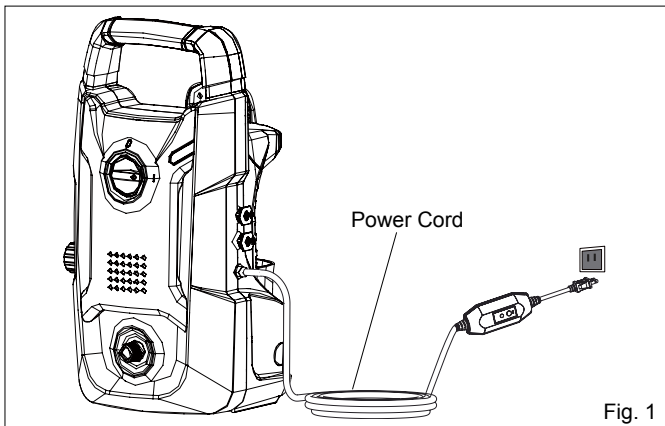

Fig. 1

GROUND FAULT CIRCUIT INTERRUPTER

This unit is equipped with a Ground Fault Circuit Interrupter (GFCI), which guards against the hazards of ground fault currents. An example of ground fault current is the current that would flow through a person who is using an appliance with faulty insulation and, at the same time, is in contact with an electrical ground such as a plumbing fixture, wet floor, or earth. GFCI plugs do not protect against short circuits, overloads, or shocks.

KNOW YOUR PRESSURE WASHER

The safe use of this product requires an understanding of the information on the tool and in this operator's manual, as well as a knowledge of the project you are attempting. Before using this product, familiarize yourself with all operating features and safety rules. (See Figure 2.)

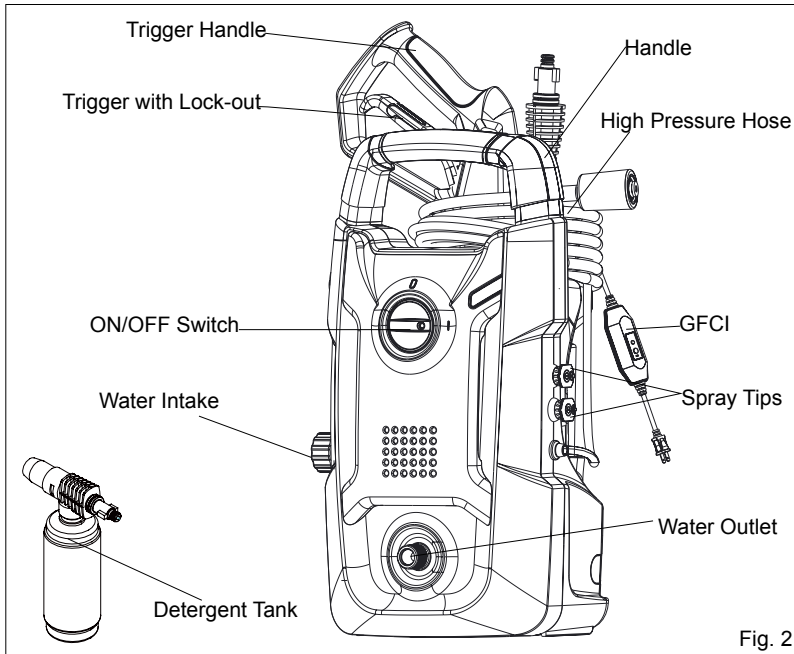

Fig. 2

DETERGENT TANK

Remove the cap from the detergent tank to add detergent to the pressure washer.

GFCI PLUG

The pressure washer is equipped with a GFCI plug to guard against the hazards of ground fault currents. This plug does not protect against short circuits, overloads, or shocks.

HIGH PRESSURE HOSE STORAGE

Once the high pressure hose is rolled, hang it on the top of the machine using the hook-and-loop strap to secure in place.

ON / OFF SWITCH

This switch turns the pressure washer on and off.

TRIGGER HANDLE

The trigger handle has a gripping surface that provides added control of the spray wand and helps reduce fatigue.

TRIGGER WITH LOCK-OUT

Pulling the trigger releases a stream of water for high pressure cleaning. The lock-out provides protection against accidental start up.





WATER INTAKE

Attach the garden hose to the water intake.

WATER OUTLET

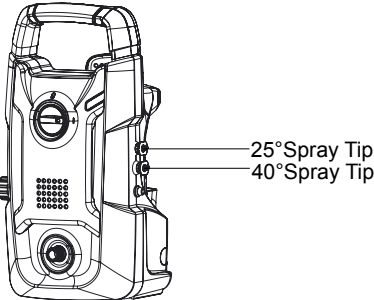
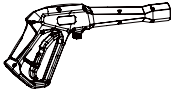
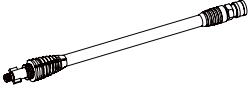
Attach the High Pressure Hose to the water outlet.

PACKING LIST

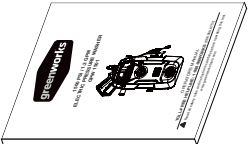
| PART NAME | ERP NO. | FIGURE | QTY |
|---|------------|---|-----|
| <ul style="list-style-type: none"> • Pressure Washer (including the spray tip) | |  | 1 |
| <ul style="list-style-type: none"> • Trigger Handle | 312021639 |  | 1 |
| <ul style="list-style-type: none"> • Wand Assembly | 312011639 |  | 1 |
| <ul style="list-style-type: none"> • 20 ft. High Pressure Hose | 31203670 |  | 1 |
| <ul style="list-style-type: none"> • Detergent Tank | 31111368 |  | 1 |
| <ul style="list-style-type: none"> • Spray Cleaner | 33201671 |  | 1 |
| <ul style="list-style-type: none"> • Quick Start Guide | 388021828A |  | 1 |
| <ul style="list-style-type: none"> • Operator's Manual | 388011828A |  | 1 |

ASSEMBLY

UNPACKING

This product requires assembly.

- Carefully remove the product and any accessories from the box. Make sure that all the contents from the packaging list are included.

WARNING

Do not use this product if any parts on the Packing List are already assembled to your product when you unpack it. Parts on this list are not assembled to the product by the manufacturer and require customer installation. Use of a product that may have been improperly assembled could result in serious personal injury.

-
- Inspect the product carefully to make sure no breakage or damage occurred during shipping.
 - Do not discard the packing material until you have carefully inspected and satisfactorily operated the product.
 - If any parts are damaged or missing, please call 1-888-909-6757 for assistance.

WARNING

If any parts are damaged or missing do not operate this product until the parts are replaced. Use of this product with damaged or missing parts could result in serious personal injury.

WARNING

Do not connect to power supply until assembly is complete. Failure to comply could result in accidental starting and possible serious personal injury.

WARNING

Do not attempt to modify this product or create accessories not recommended for use with this product. Any such alteration or modification is misuse and could result in a hazardous condition leading to possible serious personal injury.

ASSEMBLY

ASSEMBLING THE PRESSURE WASHER GUN

- Insert the male end (A) of the wand into the female bayonet outlet (B) firmly. (See Figure 3-1.)
- While pushing in the wand firmly, turn clockwise until tabs lock into place to ensure a leak-free connection. (See Figure 3-2.)

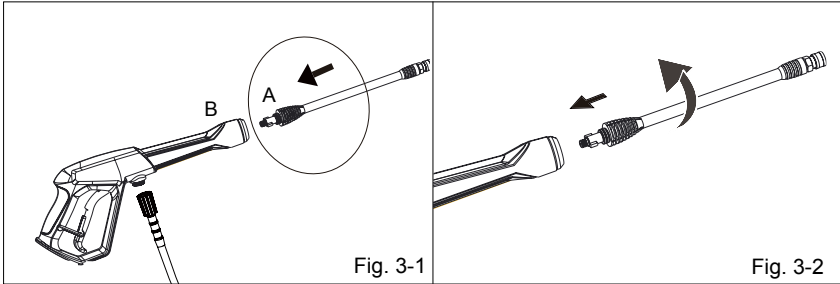

Fig. 3-1

Fig. 3-2

CONNECTING HIGH PRESSURE HOSE TO TRIGGER HANDLE (See Figure 4.)

- Connect the high pressure hose to the pressure washer gun assembly by turning the fitting clockwise. Ensure the fitting is fully tightened to the pressure washer gun.

NOTE: For easier installation of the hose to the unit or trigger it is suggested to add pressure washer or dish detergent to the rubber seal at each end of the hose. This will allow for easier installation and a snug fit.

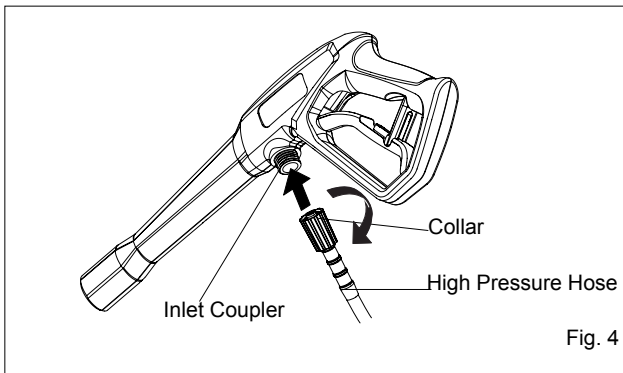

Fig. 4

ASSEMBLY

DETERGENT TANK

- Insert the male end of the bottle into the female outlet on the trigger handle. (See Figure 5-1.)
- While pushing in the bottle firmly, turn clockwise until tabs lock into place to ensure a leak-free connection. (See Figure 5-2.)
- Unscrew the bottle from the assembly and fill with pressure washer detergents/soaps only.

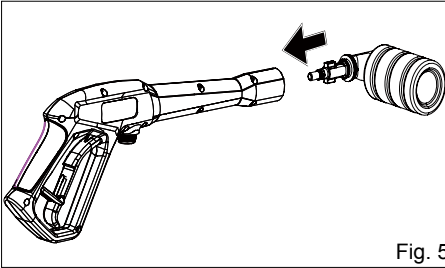

Fig. 5-1

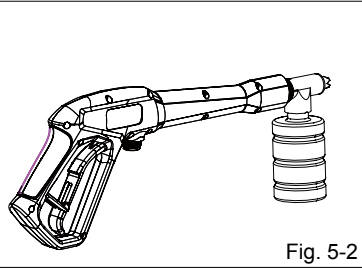

Fig. 5-2

ASSEMBLY

CONNECTING THE GARDEN HOSE (See Figure 6.)

CAUTION:

Always observe all local regulations when connecting hoses to the water main. Some areas have restrictions against connecting directly to public drinking water supply to prevent the feedback of chemicals into the drinking water supply. Direct connection through a receiver tank or back flow preventer is usually permitted.

The water supply must come from a water main. NEVER use hot water or water from pools, lakes, etc. Before connecting the garden hose:

- Uncoil the garden hose.
- Run the water hose until a steady stream of water appears to clean any debris from the hose.
- Inspect the screen in the water intake for any damage or build up of debris.
- If the screen is damaged, do not use the machine until the screen has been replaced.
- If the screen is dirty, clean it before connecting the garden hose to the machine.
- With the hose faucet turned completely off, attach the end of the garden hose to the water intake. Tighten by hand.

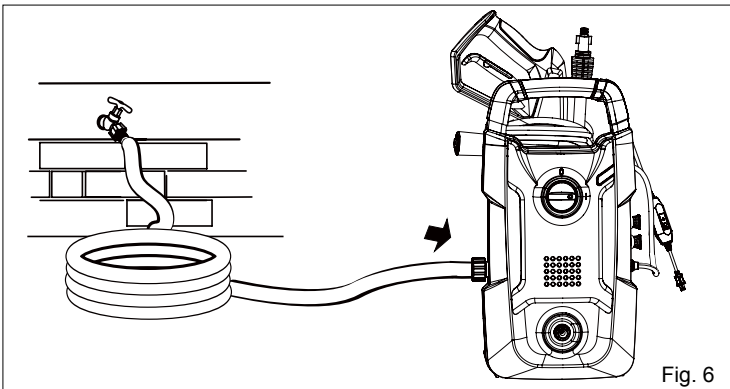

⚠ WARNING

Always ensure that the garden hose is connected to the unit and that the faucet is turned on, before the power to the unit is switched on. Pump damage will occur if these steps are not followed.

OPERATION

⚠ WARNING

Do not allow familiarity with the product to make you careless. Remember that a careless fraction of a second is sufficient to inflict serious injury.

⚠ WARNING

Never direct a water stream toward people or pets, or any electrical device. Failure to heed this warning could result in serious injury.

APPLICATIONS

You may use this product for the purposes listed below:

Cleaning cars, boats, motorcycles, outdoor furniture, grills, and house siding.

ADDING DETERGENT TO THE PRESSURE WASHER (See Figure 7.)

Use only detergents designed for pressure washers; household detergents, acids, alkalines, bleached, solvents, flammable materials, or industrial grade solutions can damage the pump.

Many detergents may require mixing prior to use. Prepare cleaning solution as instructed on the solution bottle.

- Unscrew the bottle from the soap applicator.
- Place the bottle on the ground or other stable surface.
- Fill with pressure washer detergent.
- Screw the bottle back onto the soap applicator.
- Attach the soap applicator to the trigger handle

NOTE: Use a funnel, if needed, to prevent accidental spilling of the detergent outside the tank. If any detergent is spilled during the filling process, make sure the unit is cleaned and dried before proceeding.

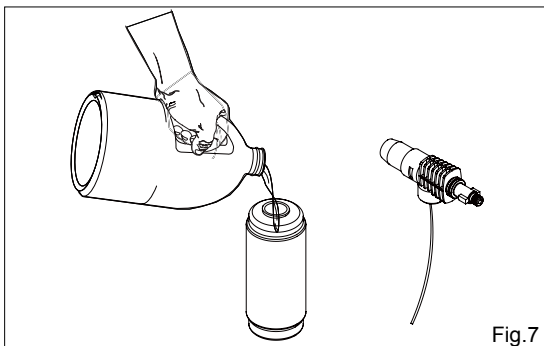

OPERATION

STARTING AND STOPPING THE PRESSURE WASHER

CAUTION :

Do not run the pump without the water supply connected and turned on.

- Connect the garden hose.
 - Turn the garden hose on then squeeze the high pressure trigger to relieve air pressure. Once a steady stream of water appears, release the trigger.
 - After ensuring the On/Off switch is in the "0/OFF" position, connect the pressure washer to the power supply.
 - Plug the pressure washer into the outlet and ensure the light on the GFCI is on, the unit is ready for operation.
 - Switch the pressure washer to the "I/ON" position to start the motor.
 - To stop the motor, release the trigger and turn the switch to the "0/OFF" position.
-

WARNING

Hold the handle and wand securely with both hands. Expect the trigger handle to move when the trigger is pulled due to reaction forces. Failure to do so could cause loss of control and injury to yourself and others.

NOTE: AUTO ON/OFF SWITCH: This Pressure washer is equipped with an Auto Start/Stop feature. To operate: Turn the power switch to the On (I) position. Pump will pressurize and shut down immediately. Once the trigger of the gun is depressed the unit will turn on. Unit will shut off and be in standby mode when trigger is released.

SOAP APPLICATION

Soap is applied under low pressure high volume for optimum performance.

Soap can not be applied under high pressure with this machine

Soap / Detergent can only be applied with this machine when the detergent tank is installed.

OPERATION

USING THE SPRAY WAND TRIGGER

For greater control and safety, keep both hands on the pressure washer gun at all times.

- Pull back and hold the trigger to operate the pressure washer.
- Release the trigger to stop the flow of water through the spray wand.

TO ENGAGE THE LOCK-OUT (See Figure 8-1.)

- Push up on the lock-out until it clicks into the slot. This will prevent any unintentional starts of the pressure washer.

TO DISENGAGE THE LOCK-OUT (See Figure 8-2.)

- Push the lock-out down and into its original position. For the most effective cleaning, the spray tip should be between 8 in. and 24 in. from the surface to be cleaned. If the spray is too close it can damage the cleaning surface.

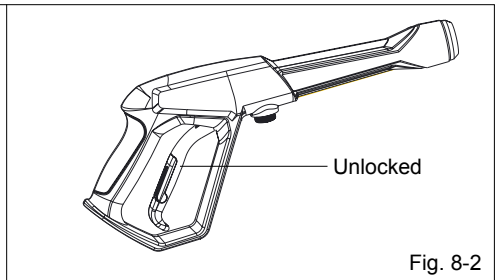
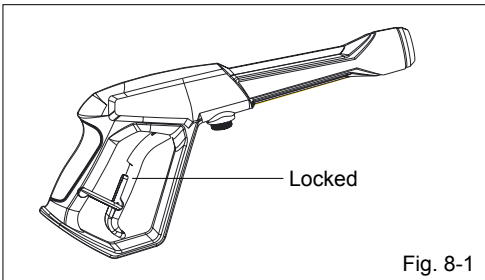

WARNING

Do not slide lock-out button when you have the trigger at back position.

OPERATION

CHANGING THE SPRAY TIP *(See Figure 9.)*



⚠ WARNING

NEVER change spray tips without engaging the lock-out on the trigger handle and NEVER point the wand at your face or at others. The quick-connect feature contains small springs that could eject the spray tip with some force. Failure to heed this may cause personal injury.

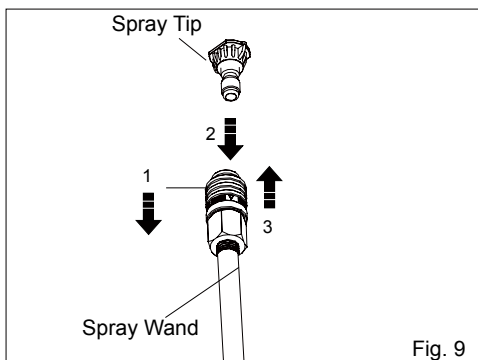
- Turn off the pressure washer and shut off the water supply. Pull trigger to release water pressure.
- Engage the lock-out on the trigger handle by pushing the trigger lock button to the right.
- Pull back the quick-connect collar on the spray wand.
- Push the spray tip into place in the spray wand.
- Push the collar forward so that the spray tip is secured properly. Check to see that the spray tip is secure.



- 1-Pull back the quick-connect collar
- 2-Push the spray tip into place
- 3-Push the collar forward

| SPRAY TIP | APPLICATION |
|---|---|
|  25° | <p>Green - Narrow fan tip (25°)</p> <ul style="list-style-type: none"> ■ The green pressure washer tip provides high versatility with its 25 degree angle tip. Referred to as the washing tip, because it provides adequate pressure to remove dirt from surfaces, but is designed to not damage many surfaces. This pressure washer tip is designed for “sweeping” foliage or debris given its wide angle. This tip is versatile due to its wide area of cleaning and strong pressure application. |
|  40° | <p>White - Wide fan tip (40°)</p> <ul style="list-style-type: none"> ■ The white 40 degree tip, referred to as the “fan” tip creates the widest area of cleaning with relatively low pressure. This pressure washer tip is best used for light or delicate cleaning applications. It is recommended for light cleaning on wood decks and other soft or delicate surfaces. |

OPERATION

OPERATING THE PRESSURE WASHER (See Figure 10.)

Use only detergents designed for pressure washers.

Soap is applied under low pressure high volume for optimum performance.

Soap can not be applied under high pressure with this machine.

To clean:

- Install the soap attachment on the spray wand.
- Start the pressure washer and spray the detergent on a dry surface using long, even, overlapping strokes. To prevent streaking, do not allow detergent to dry on the surface.

To rinse:

- Using the desired tip, spray away from the rinsing surface for approximately 10 seconds to allow any remaining detergent to be flushed from the line.
- Start at the top of the area to be rinsed and work down, overlapping the strokes.

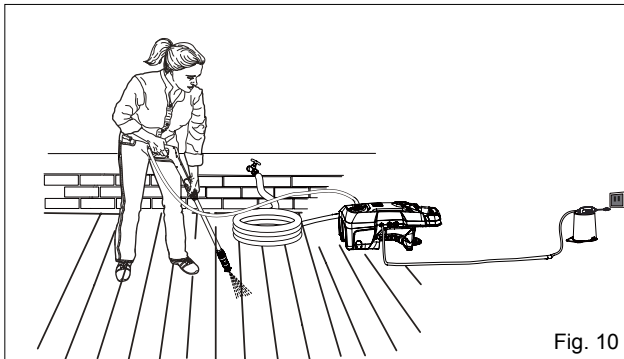

MOVING THE PRESSURE WASHER

To move the pressure washer:

- Turn the pressure washer off. Point the spray wand in a safe direction and pull trigger to release water pressure.
- Tilt the machine toward you until it balances on the wheels then roll the machine to the desired position.

MAINTENANCE

WARNING

When servicing, use only identical replacement parts. Use of any other parts may create a hazard or cause product damage.

WARNING

Before inspecting, cleaning or servicing the machine, turn off the unit, unplug from the outlet, pull trigger to release water pressure and disconnect the high pressure hose. Failure to follow these instructions can result in serious personal injury or property damage.

GENERAL MAINTENANCE

Avoid using solvents when cleaning plastic parts. Most plastics are susceptible to damage from various types of commercial solvents and may be damaged by their use. Use clean cloths to remove dirt, dust, oil, grease, etc.

WARNING

Do not at any time let brake fluids, gasoline, petroleum based products, penetrating oils, etc., come in contact with plastic parts. Chemicals can damage, weaken or destroy plastic which may result in serious personal injury.

Only the parts shown on the parts list are intended to be repaired or replaced by the customer. All other parts should be replaced at an authorized service center.

MAINTENANCE

SPRAY TIP MAINTENANCE (See Figure 11.)

Excessive pump pressure (a pulsing sensation felt while squeezing the trigger) may be the result of a clogged or dirty spray tip.

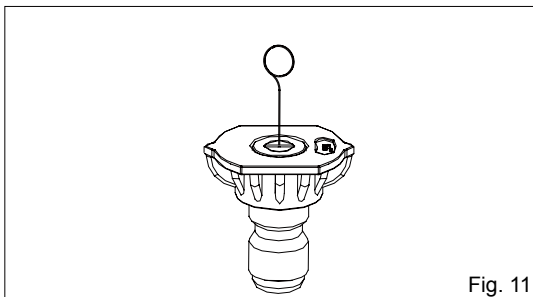

- Unplug the pressure washer.
- Turn off the pressure washer and shut off the water supply. Pull trigger to release water pressure.
- Remove the spray tip from the spray wand.

NOTE: Never point the spray wand at your face.

Using the spray cleaner provided, free any foreign materials clogging or restricting the spray tip opening. Refer to Fig. 11

- Using a garden hose, flush debris out of the spray tip by back flushing (running the water through the spray tip backwards or from the outside to the inside).
- Reconnect the spray tip to the spray wand.
- Turn on the water supply.

STORING THE PRESSURE WASHER

Store in a dry, covered area where the weather can't damage it. It is important to store this product in a frost-free area. Always empty water from all hoses, the pump, and the detergent container before storing.

NOTE: Use of a pump saver will give you better performance and increase the life of the machine.

MAINTENANCE

QUICK WINTERIZING PROCEDURE

If you cannot do the Optimum Winterizing procedure, you can still protect your pressure washer from winter damage by doing below:

- Disconnect all water connections.
- Turn on the machine for a few second, until the remaining water in the pump exits. Turn off immediately.
- Do not allow high-pressure hose to become kinked.
- Store the machine and accessories in a room that does not reach freezing temperatures. Do not store near furnace or other sources of heat as it may dry out the pump seals.

CAUTION :

Drain gun assembly of any remaining water. Aim gun downwards and squeeze trigger.

SHUTTING DOWN AND CLEANING UP

- (If you are not using detergent, go directly to Step 2.) When you have finished using the detergent injection system, fill detergent bottle with clean water. Siphon water at low-pressure for one minute so that all detergent is flushed through system. Remove detergent bottle and rinse it thoroughly.
- Disconnect the garden hose from the water inlet on the unit.
- Press trigger to release any remaining water pressure.
- Turn the switch to "OFF" (O) position.
- Unplug the power cord from the outlet.
- Engage gun safety lock.

WARNING

Turn off water supply and squeeze trigger to depressurize the unit. Failure to do so could result in personal injury due to discharge of high-pressure water.

TAKING A BREAK

If taking a break of five minutes or more.

- Engage gun safety lock.
- Turn unit to "OFF" (O) position.
- Unplug the power cord from the outlet.

IMPORTANT :

The use of a pump protector is recommended when storing to help prevent a against freezing over the winter months. It also help prevent the seals from drying out while sitting in storage in all climates.

TROUBLESHOOTING

| PROBLEM | POSSIBLE CAUSE | SOLUTION |
|------------------------------------|--|--|
| Motor will not start. | On/Off switch is in the "OFF" (O) position. | Turn switch to the "ON" () position. Squeeze gun trigger. |
| | Power cord is not plugged in. | Plug in power cord. |
| | Extension cord is too long. Extension cord is not proper gauge. Extension cord is damaged. | Replace extension cord with either a 25' (7.6 m) 14 AWG cord or a 50' (15 m) 12 AWG cord. |
| | Electrical outlet does not supply adequate power. | Try a different outlet. |
| | Tripped pressure washer circuit breaker. | Allow to cool, and restart unit. |
| Unit does not reach high pressure. | Diameter of garden hose is too small. | Replace with a 1" (25 mm) or 5/8" (16 mm) garden hose. |
| | Water supply is restricted. | Check garden hose for kinks, leaks and blockage. |
| | Not enough water supply. | Open water source fully. |
| | Pressure tip has not been installed on wand assembly. | Add desired pressure tip to end of wand. See page 18 Fig. 9 for details. |
| | Water intake filter is clogged. | Remove filter and rinse in warm water. |
| | Pump is sucking air. | Check that hoses and fittings are airtight. Turn "OFF" machine, and purge pump by squeezing trigger gun until a steady flow of water emerge through the spray tip. |
| | Detergent bottle or suction tube not properly connected. | Install detergent bottle or suction tube correctly. |
| | Detergent is too thick. | Dilute detergent. |

TROUBLESHOOTING

| PROBLEM | POSSIBLE CAUSE | SOLUTION |
|---|--|--|
| Unit does not reach high pressure. (continued) | Filter on detergent suction tube is clogged. | Run warm water through the filter to remove build up. |
| | Damaged or clogged detergent suction tube. | Remove obstruction or replace detergent suction tube. |
| | Discharge spray tip is obstructed. | Blow out or remove debris with a needle or spray cleaner. Refer to Fig. 11 in this manual. |
| Output pressure varies high and low. | Not enough inlet water supply. | Turn water on fully. Check garden hose for kinks, leaks or blockage. |
| | Pump is sucking air. | Check that hoses and fittings are airtight. Turn "OFF" machine, and purge pump by squeezing trigger gun until a steady flow of water emerge through the spray tip. |
| | Water intake filter clogged. | Remove filter and rinse in warm water. |
| | Discharge spray tip is obstructed. | Blow out or remove debris with a needle or spray cleaner. Refer to Fig. 11 in this manual. |
| | Calcified gun, hose or power spray tip. | Clean with distilled vinegar or a cleaner specifically made for the task. |
| Garden hose connection leaks. | Loose fittings. | Tighten fittings. |
| | Missing/worn rubber washer. | Replace washer. |
| Spray wand, extension, or spray tip leaks. | Broken o-ring or plastic insert. | Call the Toll-Free Helpline. |
| Pump is noisy. | Pump is sucking air. | Check that hoses and fittings are airtight. Turn "OFF" machine, and purge pump by squeezing trigger gun until a steady flow of water emerge through the spray tip. |
| | Water inlet filter clogged. | Remove filter and rinse in warm water. |
| Water leaks from pump. | Loose fittings. | Check that all fittings are tight. |
| | Water seals are damaged or worn. | Call the Toll-Free Helpline. |
| Oil is dripping. | Oil seals are damaged or worn. | Call the Toll-Free Helpline. |

TROUBLESHOOTING

| PROBLEM | POSSIBLE CAUSE | SOLUTION |
|--------------------------------|---|---|
| Motor buzzes but fails to run. | Supply voltage below minimum. | Verify that only the pressure washer is running on this circuit. |
| | System has residual pressure. | Turn unit "OFF", squeeze trigger on spray wand to release pressure, then turn unit "ON". |
| | Voltage loss due to extension cord. | Unplug any extension cords attached and plug the unit directly into the outlet. |
| | Pressure washer not used for long periods. | Call the Toll-Free Helpline. |
| | Residual friction among components. Unit might hum. | Disconnect water supply and power ON for 2 to 3 seconds, repeat couple times or until the motor starts. |
| No water. | Water supply is OFF. | Turn ON water supply. |
| | Kink in the garden hose. | Remove kink in garden hose. |

NOTE: AUTO ON/OFF SWITCH: *This Pressure washer is equipped with an Auto Start/ Stop feature. To operate: Press power switch On (I). Pump will pressurize and shut down immediately. Once the trigger of the gun is depressed the unit will turn on. Unit will shut off and be in standby mode when trigger is released.*

WARRANTY



GREENWORKS™ hereby warrants this product, to the original purchaser with **proof of purchase**, for a period of one (1) years against defects in materials, parts or workmanship. GREENWORKS™, at its own discretion will repair or replace any and all parts found to be defective, through normal use, free of charge to the customer. This warranty is valid only for units which have been used for personal use that have not been hired or rented for industrial/ commercial use, and that have been maintained in accordance with the instructions in the owners' manual supplied with the product from new.

ITEMS NOT COVERED BY WARRANTY:

1. Any part that has become inoperative due to misuse, commercial use, abuse, neglect, accident, improper maintenance, or alteration; or
2. The unit, if it has not been operated and/or maintained in accordance with the owner's manual; or
3. Normal wear, except as noted below;
4. Routine maintenance items such as draining the water to avoid freezing/ice damage to pump and components.
5. Normal deterioration of the exterior finish due to use or exposure.

GREENWORKS HELPLINE (1-888-90WORKS):

Warranty service is available by calling our toll-free helpline, at **1-888-909-6757 (1-888-90WORKS)**. Order Replacement parts online @ www.greenworkstools.com

TRANSPORTATION CHARGES:

Transportation charges for the movement of any power equipment unit or attachment are the responsibility of the purchaser. It is the purchaser's responsibility to pay transportation charges for any part submitted for replacement under this warranty unless such return is requested in writing by GREENWORKS.

EXPLODED VIEW

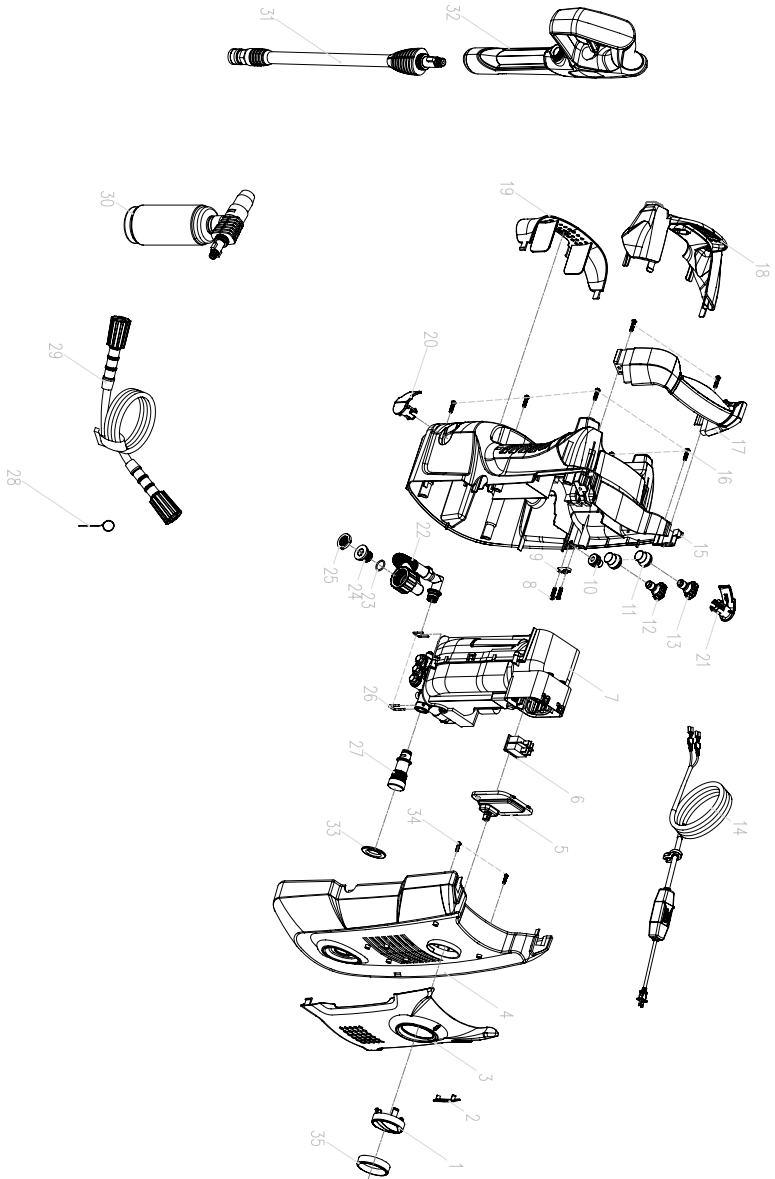

PARTS LIST

| ITEM NO. | PART NO. | DESCRIPTION | QTY |
|----------|-----------|-----------------------------|-----|
| 1 | 341091639 | Switch knob | 1 |
| 2 | 341041639 | Performance label panel | 1 |
| 3 | 341031639 | Front panel | 1 |
| 4 | 341011639 | Front housing | 1 |
| 5 | 311161639 | Switch box cover assy | 1 |
| 6 | 363021628 | Power switch | 1 |
| 7 | 311151639 | Motor & pump assy | 1 |
| 8 | 32202847 | Screw ST4.2*15-F | 2 |
| 9 | 3410801 | Power cord clamp | 1 |
| 10 | 34222302 | Power cord grommet | 1 |
| 11 | 34211319 | Nozzle grommet | 2 |
| 12 | 31225363 | 25 degree spray tip | 1 |
| 13 | 31240363 | 40 degree spray tip | 1 |
| 14 | 311021828 | Power cord assy | 1 |
| 15 | 341021639 | Back housing | 1 |
| 16 | 32202847 | Screw ST4.2*15-F | 9 |
| 17 | 311041828 | Handle assy | 1 |
| 18 | 311131639 | Back upper panel assy | 1 |
| 19 | 341061639 | Back lower panel assy | 1 |
| 20 | 341021828 | Left wheel axle hole cover | 1 |
| 21 | 341031828 | Right wheel axle hole cover | 1 |
| 22 | 311141639 | Water inlet pipe assy | 1 |
| 23 | 34213301A | O-ring | 1 |
| 24 | 33177307 | Water inlet nut | 1 |

PARTS LIST

| ITEM NO. | PART NO. | DESCRIPTION | QTY |
|----------|-----------|------------------------------|-----|
| 25 | 31901677 | Water inlet filter | 1 |
| 26 | 33307671 | Upin | 2 |
| 27 | 311171639 | Water outlet connector assy | 1 |
| 28 | 33201671 | Spray cleaner | 1 |
| 29 | 31203670 | High pressure hose assy | 1 |
| 30 | 31111368 | Low pressure soap bottle | 1 |
| 31 | 312011639 | Gun wand assy | 1 |
| 32 | 312021639 | Gun handle assy | 1 |
| 33 | 349011639 | Outlet connector seal gasket | 1 |
| 34 | 32210302A | Screw ST3.5*12 | 2 |
| 35 | 342021639 | Switch knob seal | 1 |



TOLL-FREE HELPLINE: 1-888-90WORKS (888.909.6757)

Rev: 01 (16-06-11)